



# CL-CU series

## Compact Time Delay Relay

- Delay on operate timing mode
- Fixed, knob or resistor adjustable types
- 10A output relay with DPDT contacts
- Variety of mounting options
- Various models time from 0.1 to 120 sec.
- No timing cycle interrupt transfer (CL only)

File E22575

File LR15734

Users should thoroughly review the technical data before selecting a product part number. It is recommended that user also seek out the pertinent approvals files of the agencies/laboratories and review them to ensure the product meets the requirements for a given application.

### Timing Mode

**Delay on operate** – Delay period begins when input voltage is applied. At the end of the delay period, the relay will operate and will not release until input voltage is removed. Reset occurs when input voltage is reapplied.

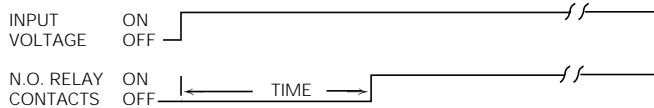

### CL Timing Specifications

**Timing Ranges:** From 0.1 to 1.0 sec. through 1.2 to 120 sec.  
**Timing Adjustment:** Fixed, external resistor and knob adjustable.  
**Tolerance (for AC units add ±1/2 cycle 60 Hz.):**  
**Knob Adj. Types:** -0, +20% of max. specified at high end of timing range; min. specified, or less, at low end.  
**Fixed Types:** ±5%.  
**Res. Adj. Types:** ±10% at high end of timing range; min. specified, or less, at low end.  
**Repeatability (for AC units add ±1 cycle 60 Hz.):** ±3%.  
**Release Time:** 100 ms, typ.; 150 ms, max.  
**Recycle Time:** 100 ms, typ.; 150 ms, max.

### CU Timing Specifications

**Timing Ranges:** From 1.0 to 10 sec. through 1.0 to 120 sec.  
**Timing Adjustment:** Fixed, external resistor and knob adjustable.  
**Tolerance (for AC units add ±1/2 cycle 60 Hz.):**  
**Knob Adj. Types:** -0, +20% of max. specified at high end of timing range; min. specified, or less, at low end.  
**Fixed Types:** ±5%.  
**Res. Adj. Types:** ±10% at high end of timing range; min. specified, or less, at low end.  
**Repeatability (for AC units add ±1 cycle 60 Hz.):** ±3%.  
**Release Time:** 150 ms, typ.; 225 ms, max.  
**Recycle Time:** 150 ms, typ.; 225 ms, max.

**Note:** On CU types the switching contact may momentarily transfer if the timing interval is interrupted. CL types have no timing cycle interrupt transfer.

### CL Ordering Information – Authorized distributors are more likely to stock boldface items listed below.

Voltage	Time	Adjustment	Wiring Dia.	Part Number
24VAC	0.1 to 10 Sec.	Knob	1	<b>CLB-51-30010</b>
24VAC	0.1 to 10 Sec.	Resistor	2	CLF-42-30010
120VAC	0.1 to 10 Sec.	Knob	1	<b>CLB-51-70010</b>
	0.3 to 30 Sec. 1.2 to 120 Sec.			<b>CLB-51-70030</b> <b>CLB-51-70120</b>
120VAC	3 Sec.	Fixed	1	CLA-41-70003
	30 Sec.			CLA-41-70030
120VAC	0.1 to 10 Sec.	Resistor	2	<b>CLF-41-70010</b>
	0.1 to 10 Sec.			<b>CLF-42-70010</b>
	1.2 to 120 Sec.			CLF-41-70120

### Contact Data @ 25°C

**Arrangements:** 2 Form C (DPDT).  
**Material:** Silver-cadmium oxide alloy.  
**Rating:** 10A @ 30VDC or 277VAC, resistive; 1/2 HP @ 250VAC; 1/3 HP @ 120VAC.  
**Expected Mechanical Life:** 10 million operations.  
**Expected Electrical Life:** 100,000 operations, min., at rated load.

### Initial Dielectric Strength

**Between Open Contacts:** 500V rms, 60 Hz.  
**Between All Other Conductors:** 500V rms, 60 Hz.

### Input Data @ 25°C

**Voltage:** 24 & 120VAC and 12 & 24VDC.  
**Power Requirement: AC Types:** Typically less than 3 VA.  
**DC Types:** Typically less than 3 W.  
**Transient Protection:** Yes.  
**Reverse Voltage Protection:** Yes.

### Input Voltages & Limits @ 25°C

Voltage Type	Nominal Voltage	Minimum Voltage	Maximum Voltage
AC	24	20	28
	120	105	130
DC	12	11	13
	24	20	32

**Note:** DC voltage must be filtered (5% p-p ripple max. at nom. voltage). AC models will operate on 50 or 60 Hz.

### Environmental Data

**Temperature Range:** **Storage:** -55°C to +85°C.  
**Operating:** -10°C to +55°C.

### Mechanical Data

**Termination:** 0.187 in. (4.75mm) quick-connect.  
**Enclosure:** Yellow plastic case (see outline drawings for various options). Knob adjustable types have dial scale for reference only.  
**Sockets:** Solder, printed circuit and screw terminal sockets available.  
**Weight:** 3.5 oz. (99g) approximately.

Voltage	Time	Adjustment	Wiring Dia.	Part Number
12VDC	0.1 to 10 Sec.	Knob	1	CLD-51-20010
12VDC	10 Sec.	Fixed	1	CLC-41-20010
12VDC	1.2 to 120 Sec.	Resistor	2	CLH-41-20120
24VDC	5 Sec.	Fixed	1	CLC-41-30005
24VDC	0.1 to 10 Sec.	Resistor	2	<b>CLH-41-30010</b>
	0.3 to 30 Sec.			CLH-41-30030
	0.1 to 10 Sec.			CLH-45-30010

41 style models (e.g. CLA-41-70010) have plain case.  
 42 style models (e.g. CLF-42-70010) have bracket mount case.  
 45 style models (e.g. CLH-45-30010) have bracket mount case with test button.  
 51 style models (e.g. CLB-51-30010) have plain case with knob.

**CU Ordering Information – Authorized distributors are more likely to stock boldface items listed below.**

Voltage	Time	Adjustment	Wiring Dia.	Part Number
24VAC	10 Sec.	Fixed	1	<b>CUA-41-30010</b>
24VAC	1 to 10 Sec.	Resistor	2	<b>CUF-41-30010</b>
	1 to 10 Sec.			CUF-42-30010
120VAC	1 to 10 Sec.	Knob	1	<b>CUB-51-70010</b>
	1 to 30 Sec.			<b>CUB-51-70030</b>
	1 to 60 Sec.			<b>CUB-51-70060</b>
	1 to 120 Sec.			<b>CUB-51-70120</b>
120VAC	1 Sec.	Fixed	1	<b>CUA-41-70001</b>
	3 Sec.			<b>CUA-41-70003</b>
	3 Sec.			CUA-42-70003
	5 Sec.			<b>CUA-41-70005</b>
	10 Sec.			<b>CUA-41-70010</b>
	10 Sec.			CUA-42-70010
	30 Sec.			CUA-42-70030
120 Sec.	CUA-41-70120			

Voltage	Time	Adjustment	Wiring Dia.	Part Number
120VAC	1 to 10 Sec.	Resistor	2	<b>CUF-41-70010</b>
	1 to 10 Sec.			<b>CUF-42-70010</b>
	1 to 30 Sec.			<b>CUF-41-70030</b>
	1 to 120 Sec.			<b>CUF-41-70120</b>
	1 to 120 Sec.			<b>CUF-42-70120</b>
24VDC	1 to 10 Sec.	Resistor	2	<b>CUH-41-30010</b>
	1 to 10 Sec.			<b>CUH-42-30010</b>
	1 to 120 Sec.			<b>CUH-41-30120</b>
	1 to 120 Sec.			CUH-42-30120

41 style models (e.g. CUA-41-70010) have plain case.  
42 style models (e.g. CUA-42-70010) have bracket mount case.  
51 style models (e.g. CUB-51-70010) have plain case with knob.

**Outline Dimensions**  
41 Style

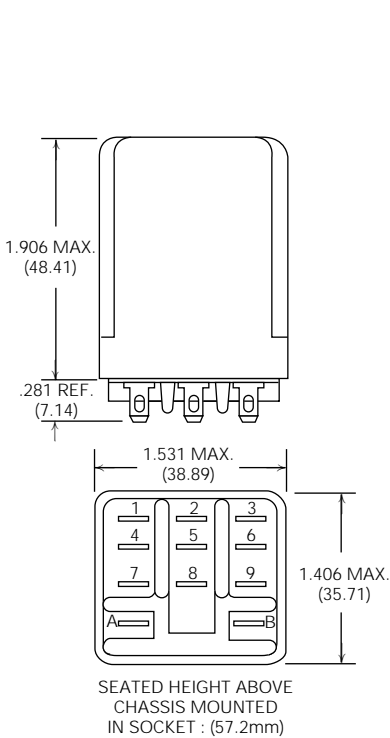

42 & 45 Style

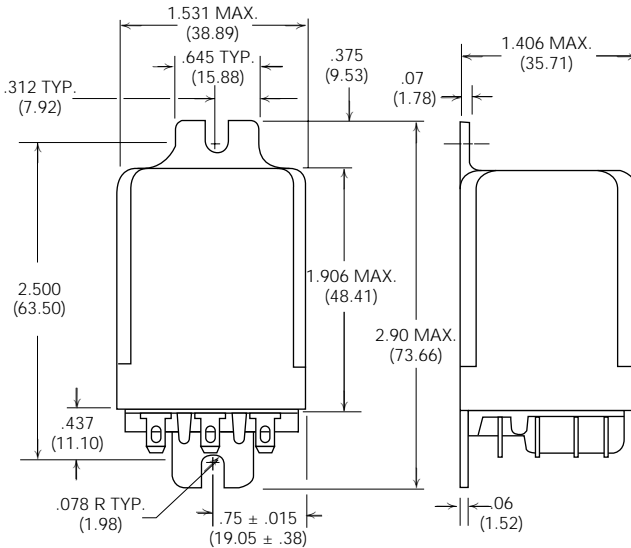

51 Style

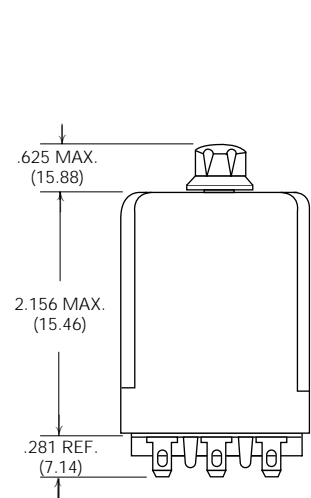

**Terminal Dimensions**

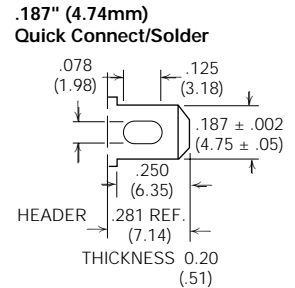

**Wiring Diagrams – Bottom Views**

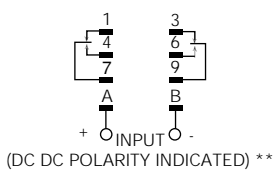

Fig. 1

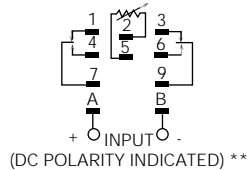

Fig. 2

\*\* Note: Input polarity for DC operation. For most reliable operation on AC, connect high side to "+" and low side to "-".

**External Resistor Selection Chart**

See External Resistor Selection Charts at beginning of Time Delay Relay section of this Databook.